

### PART LIST

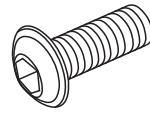

H1X7PCS

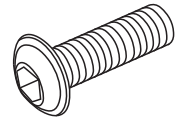

H2X6PCS



H3 X1PC

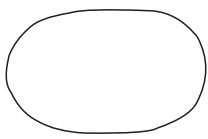

P1X1PC

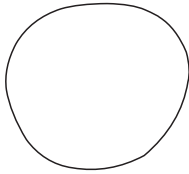

P2X1PC

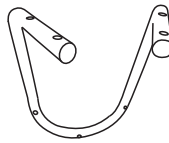

③ X1PC

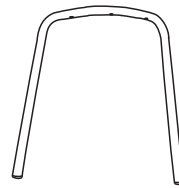

④ X1PC

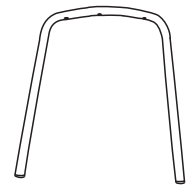

⑤ X1PC

### Step 1

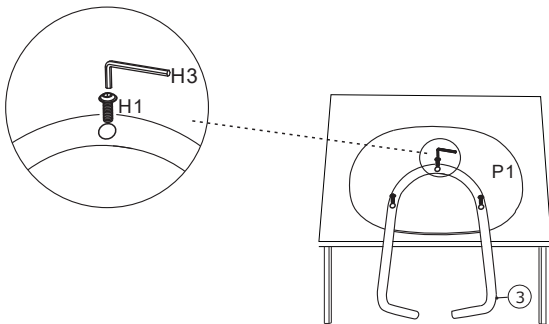

### Step 3

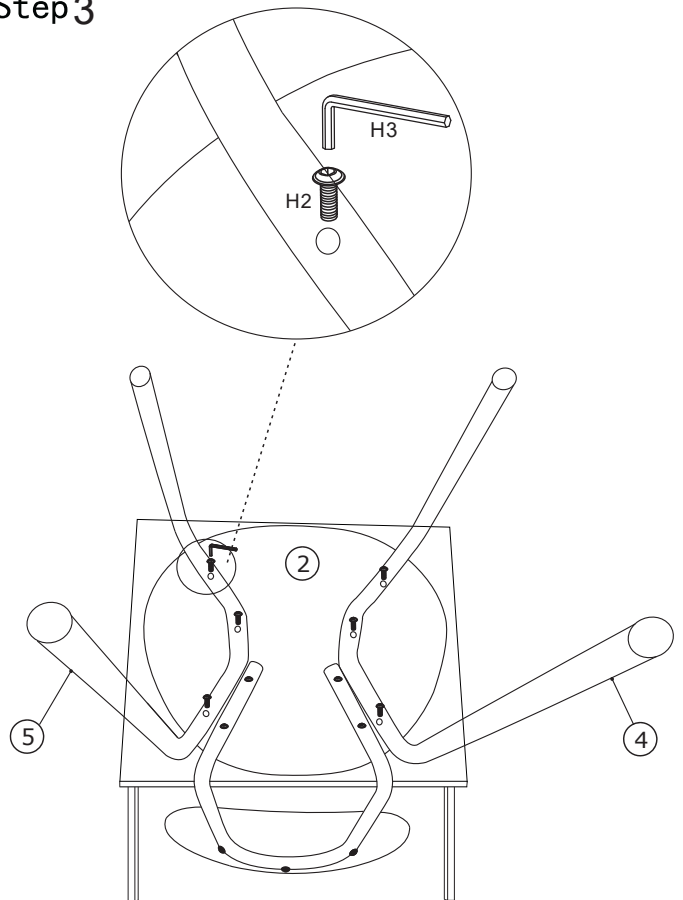

### Step 2

